

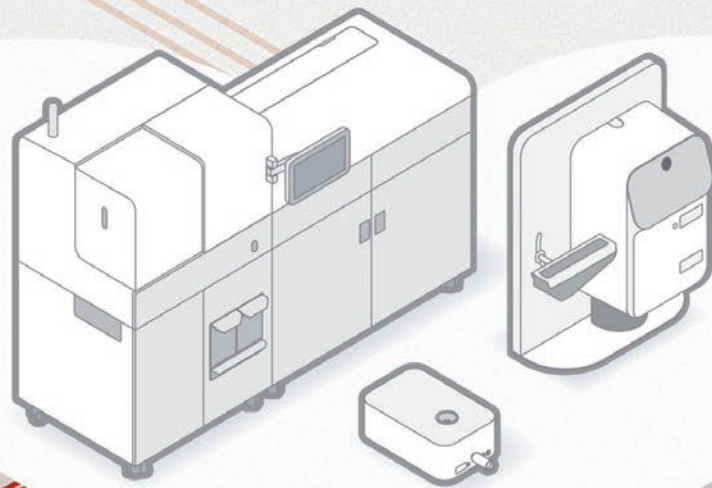

# Tempus600®

The heart of pre-analytical  
sample flow management



Tempus600® - Revolutionizing the way small  
laboratory samples are transported

# What we do

- ✓ Connect sample flow from all departments with the laboratory
- ✓ Optimize and manage sample flow
- ✓ Save valuable time and resources in hospitals and laboratories

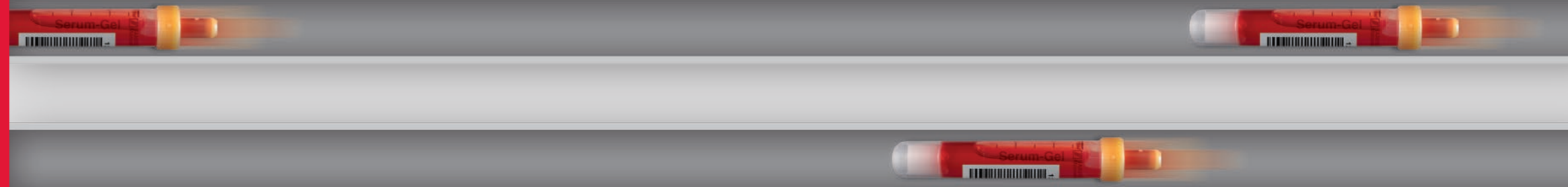

At SARSTEDT, we believe that everything is connected. That connectivity gives assurance. This is our method. With automated sample flows, we can connect all hospital and laboratory departments. We improve and streamline the transport and handling of small clinical samples.

## Nothing less than revolutionary

Tempus600® provides automated sample flow management in hospitals and laboratories worldwide. The system guarantees rapid turnaround times for all samples – securely, easily and of the highest sample quality. With modular and scalable options, we tailor solutions to specific needs in all hospital environments.

Tempus600® systems play a central role in the pre-analytical process thanks to fast and predictable transportation. The system can handle a high volume of samples with a single touch.

## Ease, control and job satisfaction

One-touch solutions eliminate time-consuming manual processes, make the transportation of samples more efficient and ensure your daily work runs more smoothly. The system is operated easily and intuitively, and once the samples are delivered, you don't need to look back – Tempus600® takes over and delivers the samples directly onto the laboratory's automated line.



## Savings and patient satisfaction

Everything fits together. People are social creatures. We need to be seen and met. Tempus600® makes this possible – even in those situations where every second counts. With automated sample flow management, there is time to meet the individual patient. Sample after sample. With an automatic and continuous flow 24/7, there is no risk of either wrong deliveries or peak demand times in the laboratory. The patient receives a quick response and can be discharged sooner.

# One-touch management system

With our automated one-touch systems, samples are brought directly from the ward to the lab in seconds, with no sample packing and unpacking, delays or misdeliveries. It's like having a lab right next to the patient!

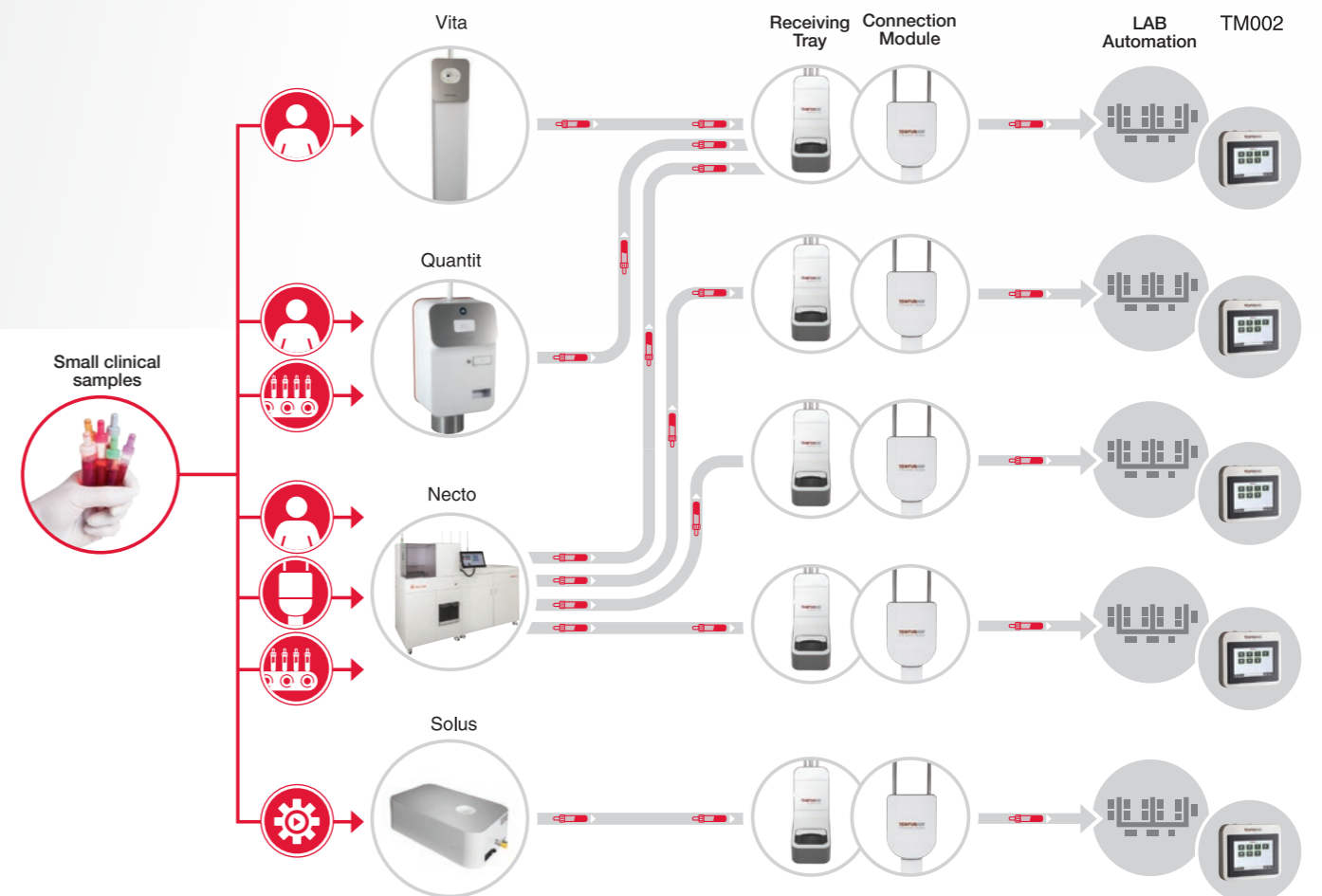

## What are automated one-touch solutions for small clinical samples?

When we say one-touch, we mean it literally. That is, a single fingerprint on a test tube – from the time the sample is taken to the answer waiting with the responsible doctor.

Our one-touch management system eliminates the need for additional packing and unpacking of small clinical samples. The sample is placed in Tempus600®, which transports it to the laboratory in a matter of seconds. One-touch management thus saves critical time and reduces the probability of error. It also frees up resources and gives you the opportunity to focus on other tasks.

## Why is it important to be able to send small clinical samples?

Small clinical samples make up on average at least 75% of the items sent through conventional tube systems. But even this mode of transport is often time-consuming, as the samples need to be prepared and packed manually before they can be sent.

The Tempus600® system significantly reduces the load on existing pneumatic tube systems and not least, reduces both response times and the need for manual labour.

## How does it work?

Depending on which Tempus600® system is used, the samples can either be filled manually, robotically, via conveyor or from the Tempus600® connection module.

Upon arrival in the laboratory, the samples are received in either a manual tray or directly via the Tempus600® connection module, which is integrated with the laboratory's automation systems, including bulk loaders and sorters.



# Lab-to-lab transport

of small laboratory samples ensures direct fast track between the laboratories

Automated transport of internal samples between two laboratories improves workflows and frees up time and resources for other tasks.

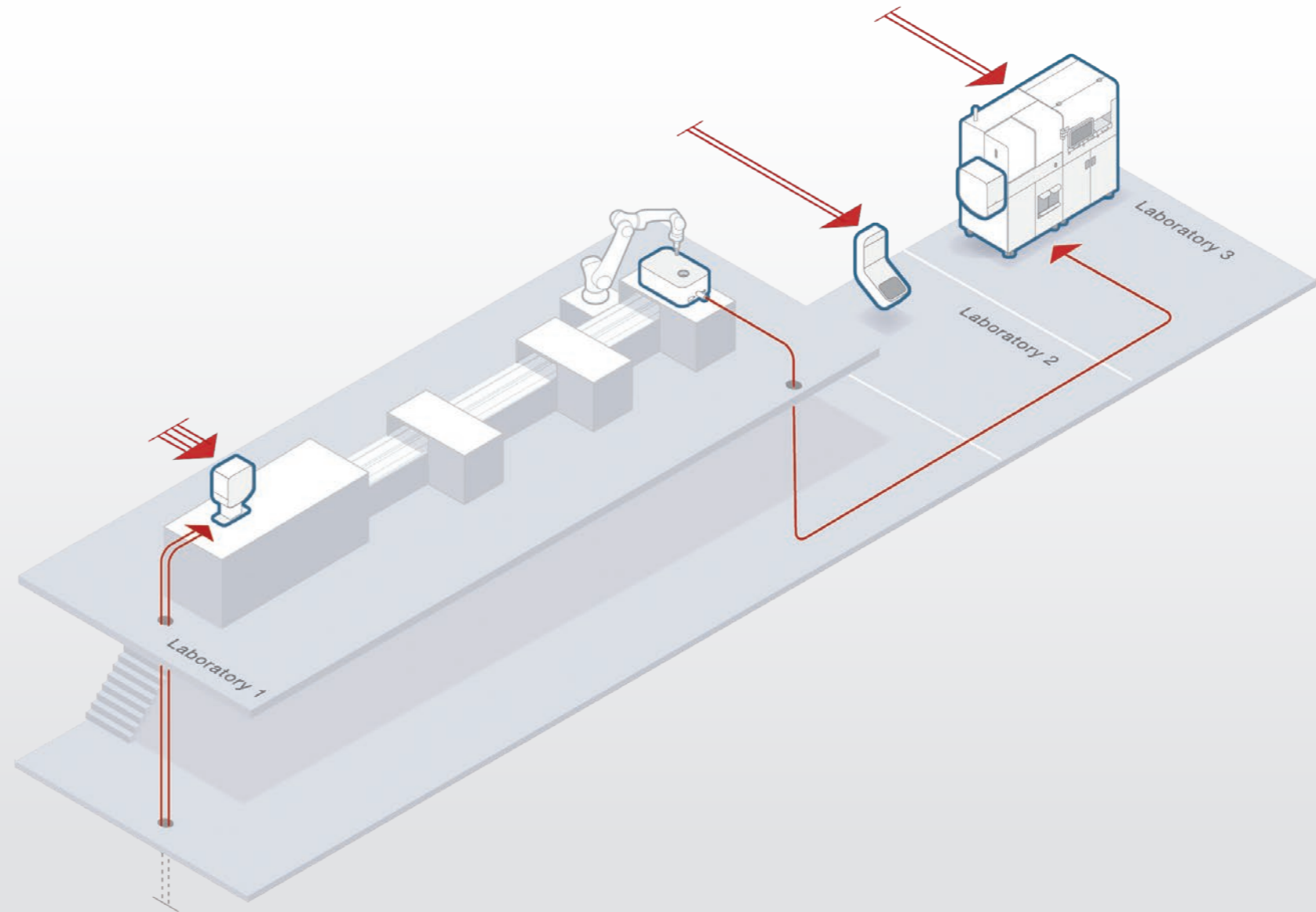

The samples arrive in the receiving tray where they can be easily retrieved by staff.



The Tempus600® connection module, as part of an automated one-touch handling system for samples tubes, provides a wide range of benefits, such as fewer work procedures, hands-free sample tube handling and generally faster and safer handling.

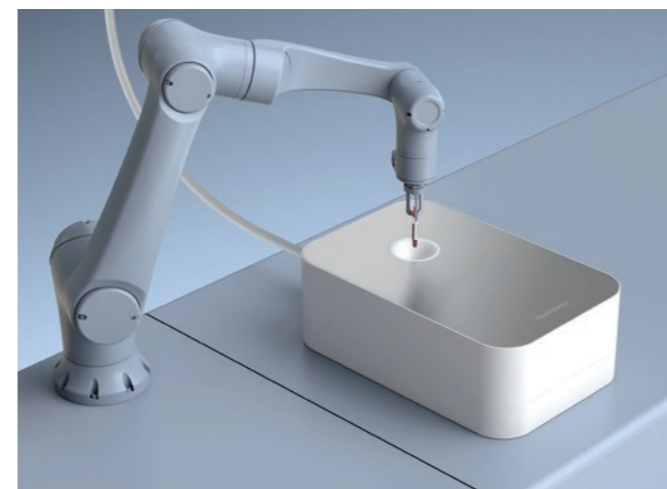

Samples must be quality checked and approved by the automation solution before they are loaded into Tempus600® Solus and sent directly to the destination.

## Lab-to-lab transport

The central laboratory receives large quantities of small laboratory samples and incoming samples from GPs. Some samples are sent to specialized laboratories for analysis, while others are sent from the storage facility for disposal. Cramped conditions in laboratories combined with high demand for an efficient production flow require lean processes that can streamline the daily work.

Tempus600® Solus helps with the quick and reliable transportation of small samples between two laboratories or from the laboratory to an alternative destination. This eliminates delays in transport between two laboratories and maintains an efficient production flow across all departments.

# Phlebotomy

with automated handling and transportation of high sample volumes

Automated blood sample infeed and distribution makes logistics a support function that you hardly notice.

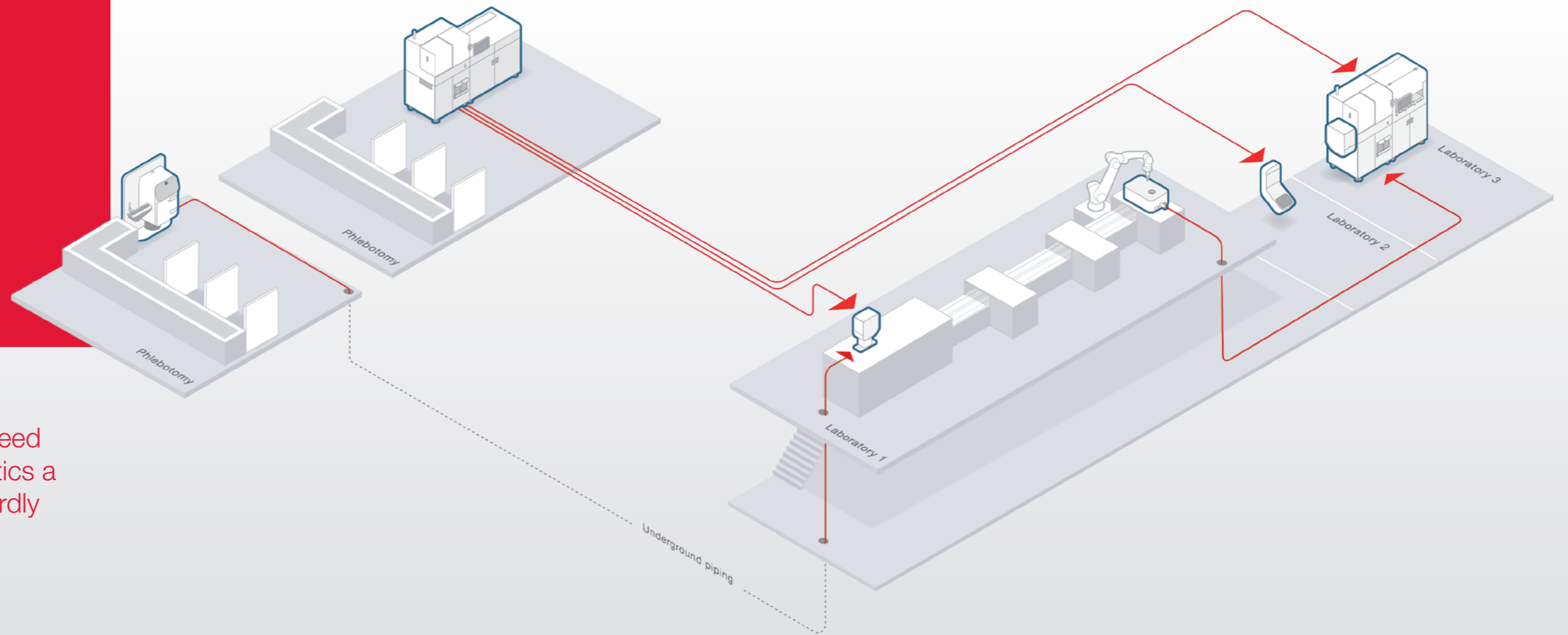

Tempus600® Quantit SL meets the need for automated loading and transport of blood samples to a single destination.



Samples are automatically received in the Tempus600® Quantit SL using a side-loader module that can be connected to a conveyor belt.



Tempus600® Necto can either be connected to a conveyor belt or samples can be loaded manually. The system streamlines the entire registering and sorting process, allowing samples to be transferred to up to six different destinations.

## Phlebotomy automation

In sampling with a high sample volume, it is essential that efficient logistics are in place that can streamline sample flow and give peace of mind to the patients. Depending on your needs and the chosen solution, samples will be automatically sent directly to one or more destinations with just one touch.

With Tempus600® Quantit SL, the samples are automatically fed via a conveyor belt into the system and sent directly to a single destination.

Tempus600® Necto streamlines the entire registering and sorting process, allowing samples to be transferred to up to six different locations.

The Tempus600® automated one-touch systems eliminate manual procedures and reduce the number of people in the room. This gives peace of mind, reduces stress and allows staff to focus on patients.

# Sample reception

Sample reception with automated one-touch handling and transport of incoming samples from GP's, external laboratories or external hospitals.

LIS connectivity, sorting criteria, traceability and point-to-point delivery provide full assurance that samples are delivered to the right destination. You don't even have to think about it!

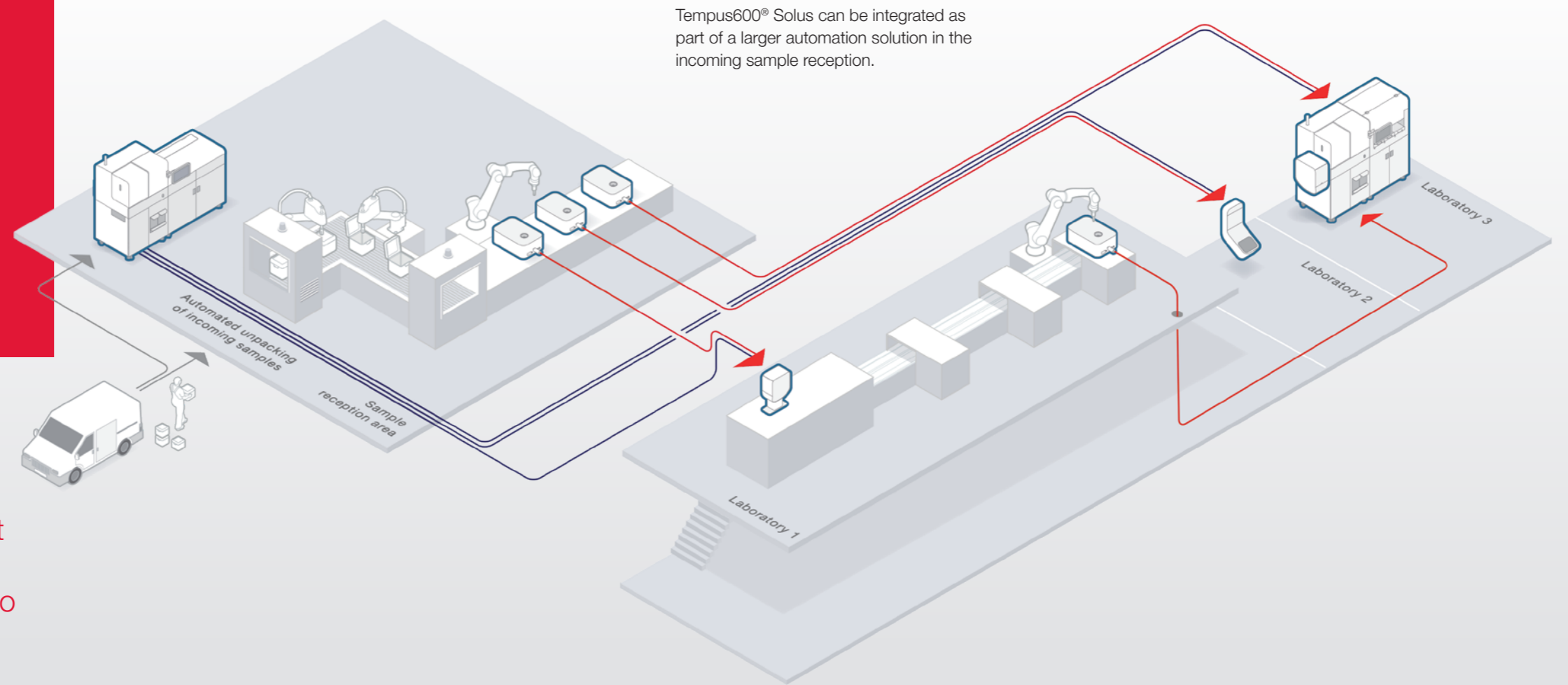

Tempus600® supports the automation of reception areas streamlining the sorting, registering and transporting of samples over long distances.



Tempus600® Solus is used to redistribute samples after unpacking. If more than one destination is required, simply add an equivalent number of sending stations.

## Sample reception area sorting and transport

Incoming samples in sample receiving areas can create bottlenecks related to manual handling and later, when the samples need sorting in the lab.

But it doesn't have to be like this! Just imagine that the receipt of small laboratory samples and incoming samples from medical practices can be automatically received, sorted, recorded and sent to the respective destinations in one continuous flow. Entirely without manual processes. That is exactly what Tempus600® Necto can do!

The one-touch system also applies to incoming samples from GPs and drastically reduces the total turnaround time for samples. Transport boxes with external samples are placed in the unpacking station, which opens the boxes, sorts and records the samples, after which a robot arm guides the samples into Tempus600® Solus, which sends them individually directly to the lab.

Automatic handling and transportation of samples eliminates time-consuming manual work and minimizes error. It's a solution that requires well-developed logistics and a high degree of automation.

# The heart of sample flow management

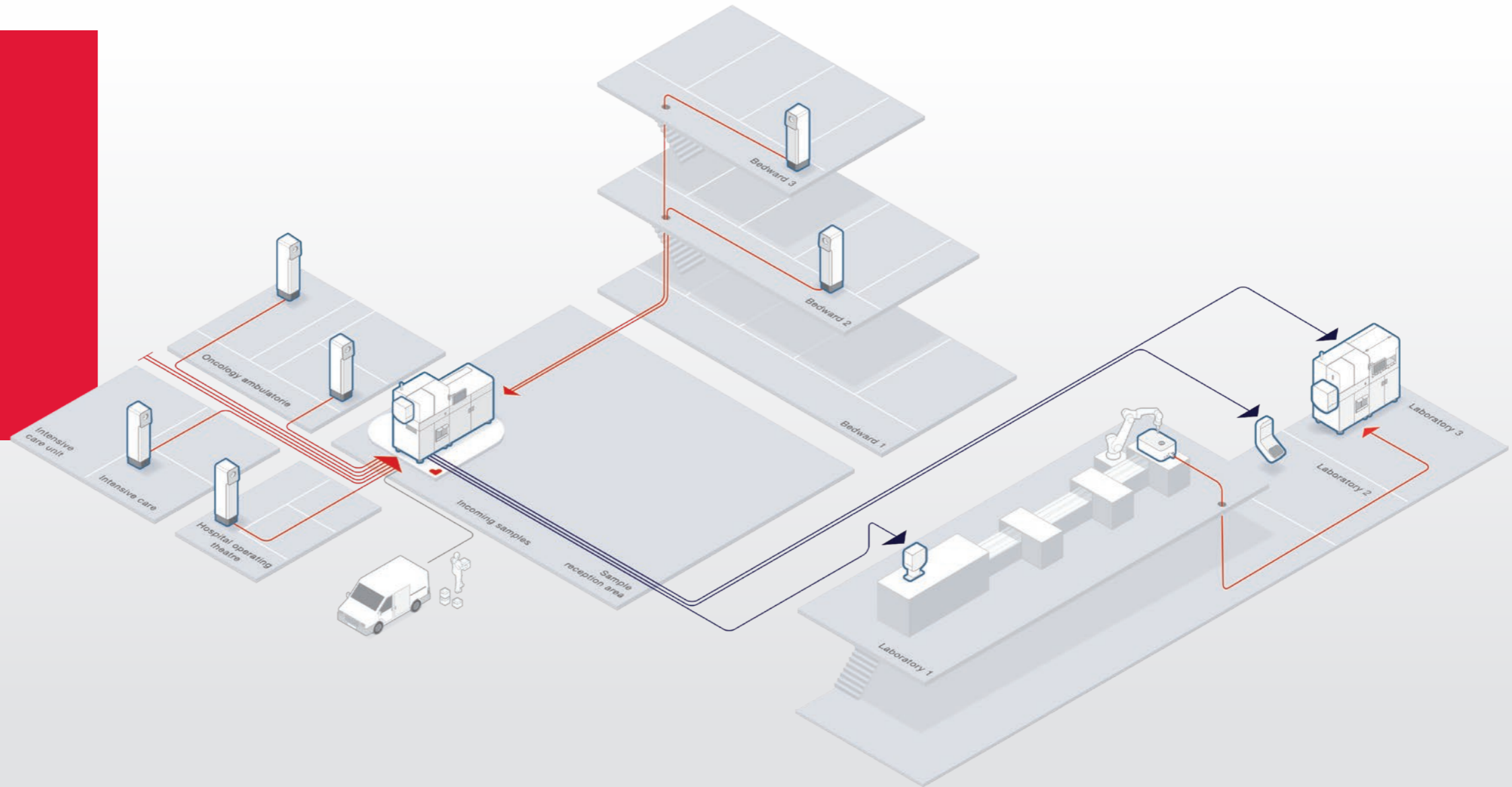

Tempus600® Necto operates as a redistribution center for samples sent from hospital departments via the Tempus600® system or conventional systems.



## The heart of sample flow management

Tempus600® Necto is the beating heart in the management of small samples. It binds pre- and post-analytic automation together – and is fully automated. All functions are gathered into one single solution – from receiving the samples, sorting and registration to further distribution to up to six different destinations.

Necto receives a constant flow of samples from different sites – either via the connection module, the conveyor or manual input. The samples are processed and sent onwards to the laboratory, where they are either deposited in a Tempus600® receiving tray or sent directly out on a track via the Tempus600® connection module.

Sample flow management provides extra capacity and is relevant

- when there is a lack of time to control sample flow
- when automating manual sample handling
- when you need fast and secure handling, sorting and distribution of samples.

.....> sample loading      .....> sample identification      .....> sorting and distribution

# Overview

of hospital and laboratory setup with Tempus600® one-touch solutions

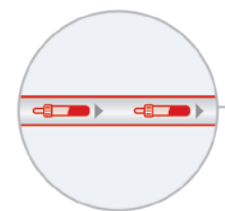

Transport pipelines for blood and small laboratory samples

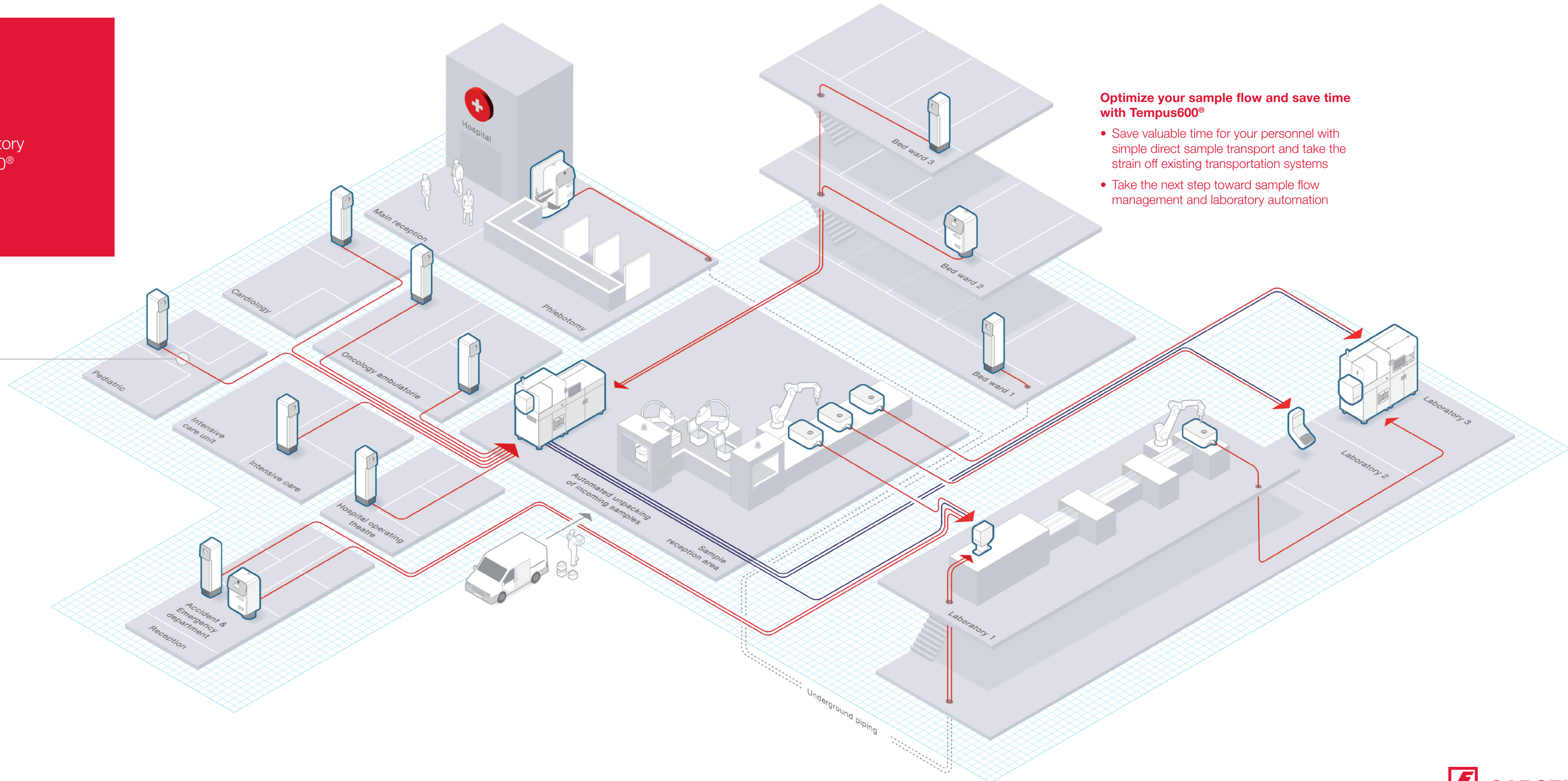

## Optimize your sample flow and save time with Tempus600®

- Save valuable time for your personnel with simple direct sample transport and take the strain off existing transportation systems
- Take the next step toward sample flow management and laboratory automation



# Facts

# Pre-analytical workflow powered by SARSTEDT

Take advantage of the synergy of our synchronized systems

### Easy installation and maintenance

Tempus600® is a compact system designed to function efficiently. It can be installed in just two weeks without the disruption of construction. Should it become necessary to relocate, the system can be moved without difficulty to a new place in a different building or another part of the hospital.

### Uptimes and reliability

Tempus600® solutions are extremely reliable. With an impressive uptime of 99.93%, operating costs are considerably reduced. In addition, our support team is capable of performing the vast majority of troubleshooting externally – with Tempus600®, you are in the best hands!

### Modular, scalable solutions

The modular design makes it easy to integrate and expand the Tempus600® solutions. Regardless of whether you need a single system or a comprehensive hospital-wide concept, you can integrate Tempus600® and expand it later to fulfil new needs. The flexible and scalable systems make it possible to combine complete logistics solutions for configuration, so the entire sample flow is streamlined and optimized.



Cool facts

Countries

28

Hospitals

226

Installations

668

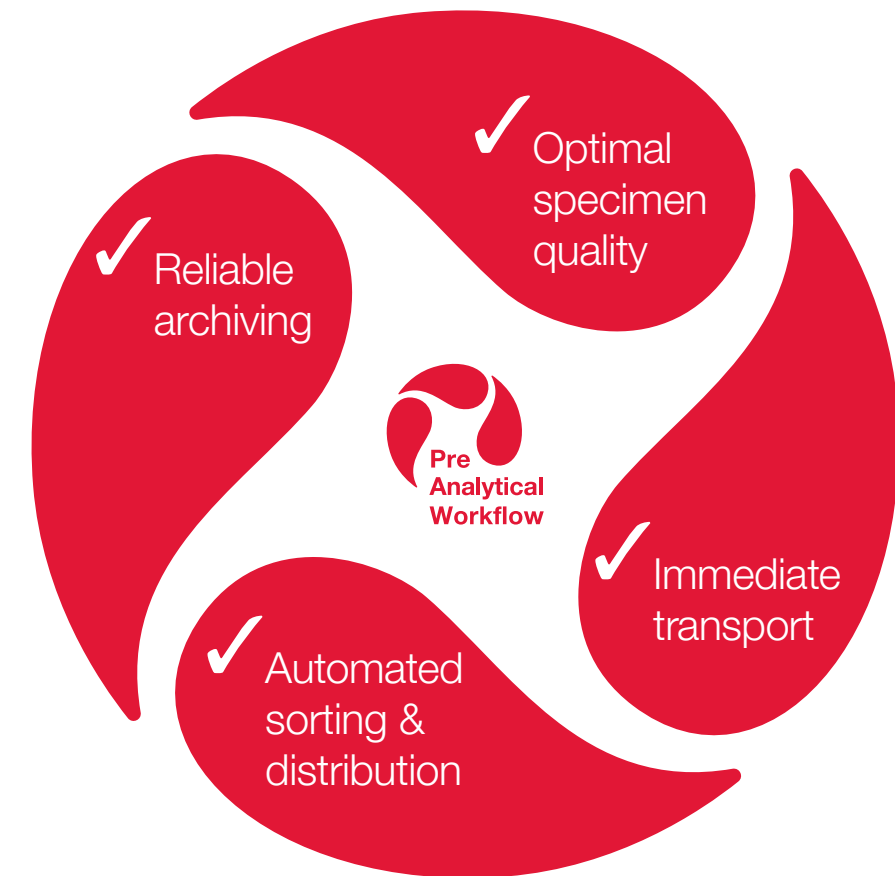

**TEMPUS600®**  
*One-touch for better treatment*

Discover the 360° solutions for your pre-analytics from SARSTEDT



[workflow.sarstedt.com](http://workflow.sarstedt.com)



SARSTEDT, Inc. • 1025 St. James Church Road • P.O. Box 468 • Newton, NC 28658 - 0468  
Toll free: +1 800 257 5101 • Fax: +1 828 465 4003  
[customerservice.us@sarstedt.com](mailto:customerservice.us@sarstedt.com) • [www.sarstedt.com](http://www.sarstedt.com)